





MDW5/5-10

5 cable Wide Band taps -10dB

-  **4 Wide Band lines from 250 to 2400 MHz**
-  **1 Terrestrial line 5 ...790MHz**
-  **Low loss of passage**
-  **High isolation between inputs**

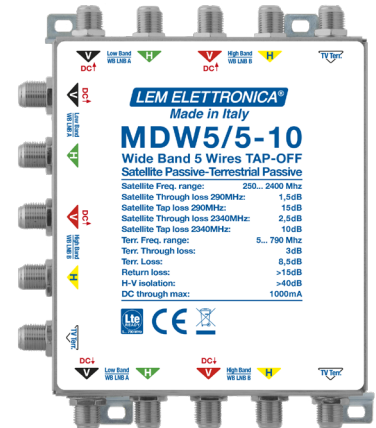

5
 WARRANTY YEARS

MODEL		MDW5/5-10
SATELLITE FREQUENCY RANGE	MHz	250... 2400
SATELLITE INPUTS / OUTPUTS		4
SATELLITE TAPS		4
SATELLITE TRUNK LOSS	dB	≤ 2,5
SATELLITE TAP LOSS	dB	10
TV TERRESTRIAL FREQUENCY RANGE	MHz	5... 790
TV TERR. INPUT / OUTPUT		1
TV TERRESTRIAL TAP		1
TV TERRESTRIAL TRUNK LOSS	dB	3
TV TERRESTRIAL TAP LOSS	dB	8,5
INPUTS / OUTPUTS ISOLATION	dB	> 30
RETURN LOSS	dB	> 10
MAX. CURRENT LINE VL + VH	mA	1000 + 1000
DIMENSIONS	mm	118x140x30

Connection Diagram

▶ Example of cascading a single satellite with **LNB Quattro** and mixing terrestrial signals

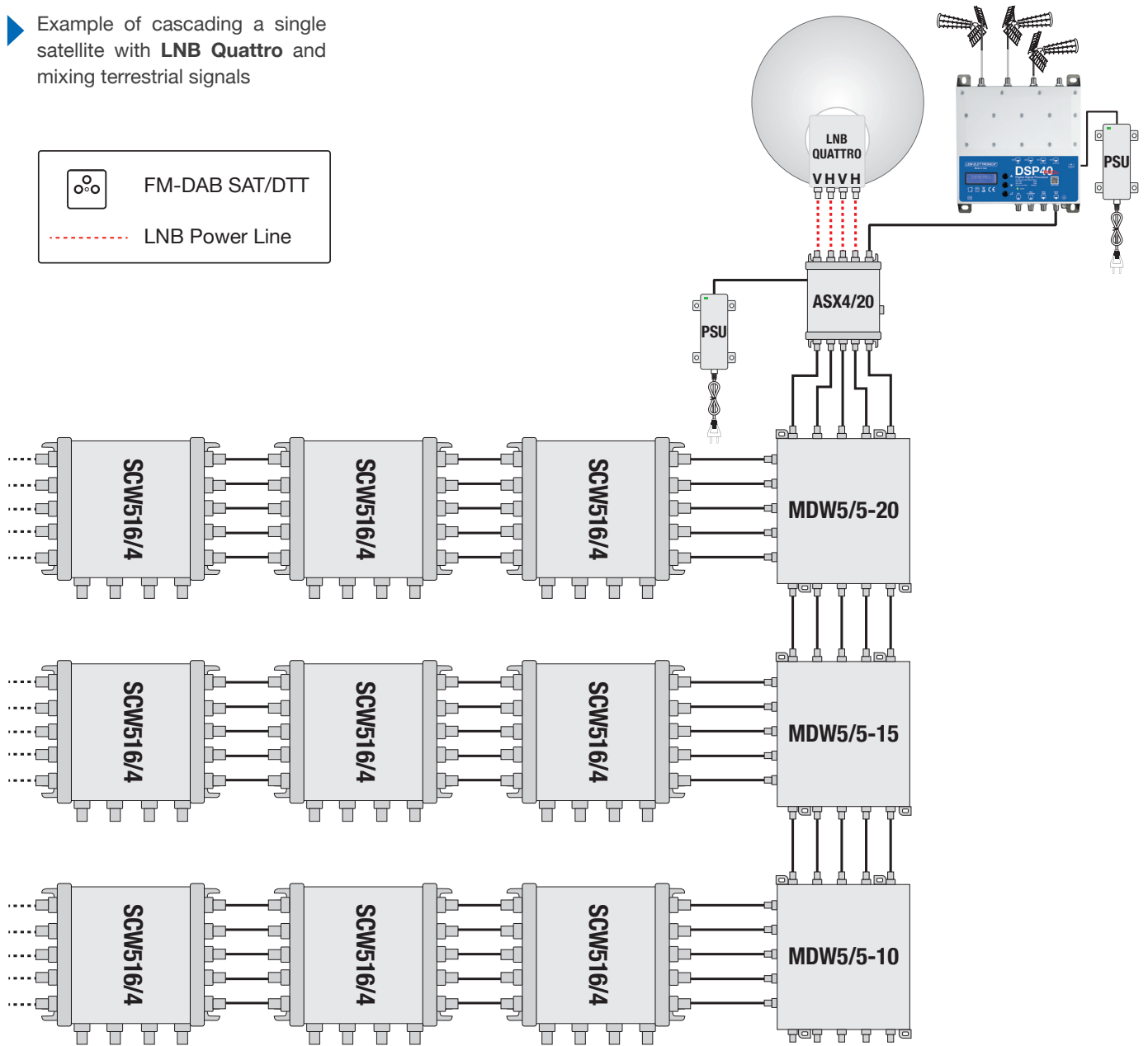
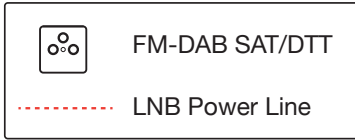

Connection Diagram

▶ Example of cascade distribution with two Wide Band LNBS for two satellites and mixing of terrestrial signals

