







DSP15

NFC Programmable Multiband Amplifier

-  **Contactless NFC smart phone programmable**
-  **App available for iOS and Android**
-  **32 High Selectivity channel filters with ACG**
-  **Lte700 5G SAW filter technology protection**
-  **Integrated high-efficiency power supply**
-  **DIN rail and wall mounting**

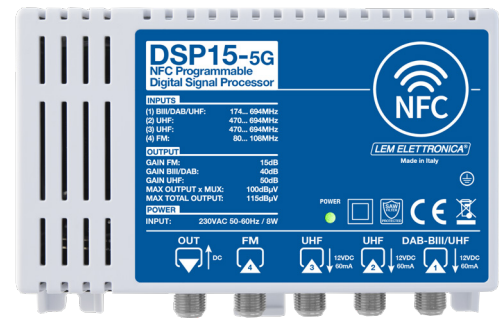

Compact and versatile MATV amplifier for the amplification of terrestrial signals coming from several antennas.

The all parameters (channel filters, output level, slope, etc...) are managed by a smartphone App (Android or iOS) in a friendly and intuitive environment. The configurations can be saved and recalled in the smartphone memory - even without being connected to the amplifier.

The amplifier integrates a high-efficiency low-power consumption switch-mode power supply. Can be also remotely powered over the output coaxial cable.



MODEL		DSP15
NUMBER OF INPUTS		1xFM / 1xDAB/BIII/UHF / 2xUHF
INPUTS FREQUENCY RANGE	MHz	FM (88... 108) BIII (170... 230) / DAB (170... 240) UHF (470... 694)
LTE PROTECTION		LTE 700
SINGLE CHANNEL FILTERS		32
NUMBER OF CHANNEL PER FILTERS		1 / 2 (selectable)
COMMUNICATION STANDARD		NFC (Near Field Communication)
INPUT LEVEL RANGE	dBµV	FM 35... 90 - BIII/DAB 45... 100 - UHF 45... 90
BIII/DAB/UHF INPUT PRE-AMPLIFIER	dB	OFF= 0 / ON= +16
AUTOMATIC GAIN CONTROL RANGE	dB	40 dB
DIGITAL FILTERS SELECTIVITY	dB	35 @1MHz
FM GAIN	dB	-10/+15
BIII/DAB GAIN	dB	40... 50
UHF GAIN	dB	60
TOTAL OUTPUT LEVEL RANGE	dBµV	85... 105
BIII/DAB LEVEL ADJUSTMENT		0... -10
UHF SLOPE ADJUSTMENT	dB	0... +5
MAX TOTAL OUTPUT LEVEL	dBµV	115
RETURN LOSS IN/OUT	dB	>10
AERIAL INPUTS REMOTE POWERING		12V/ 60mA
INPUT VOLTAGE	V	100... 240VAC 50/60Hz
MAXIMUM CONSUMPTION	W	8
OPERATING TEMPERATURE	°C	-15... 40
DIMENSIONS	mm	135 x 91 x 45

Programming & Connection diagram

Manual Programming

With the LEM NFC smartphone application, you can have access to the configuration of all the control panel parameters in a simple and intuitive way. The connection to the DSP15-5G control panel occurs without contact via NFC by bringing the smart phone close to the control panel.

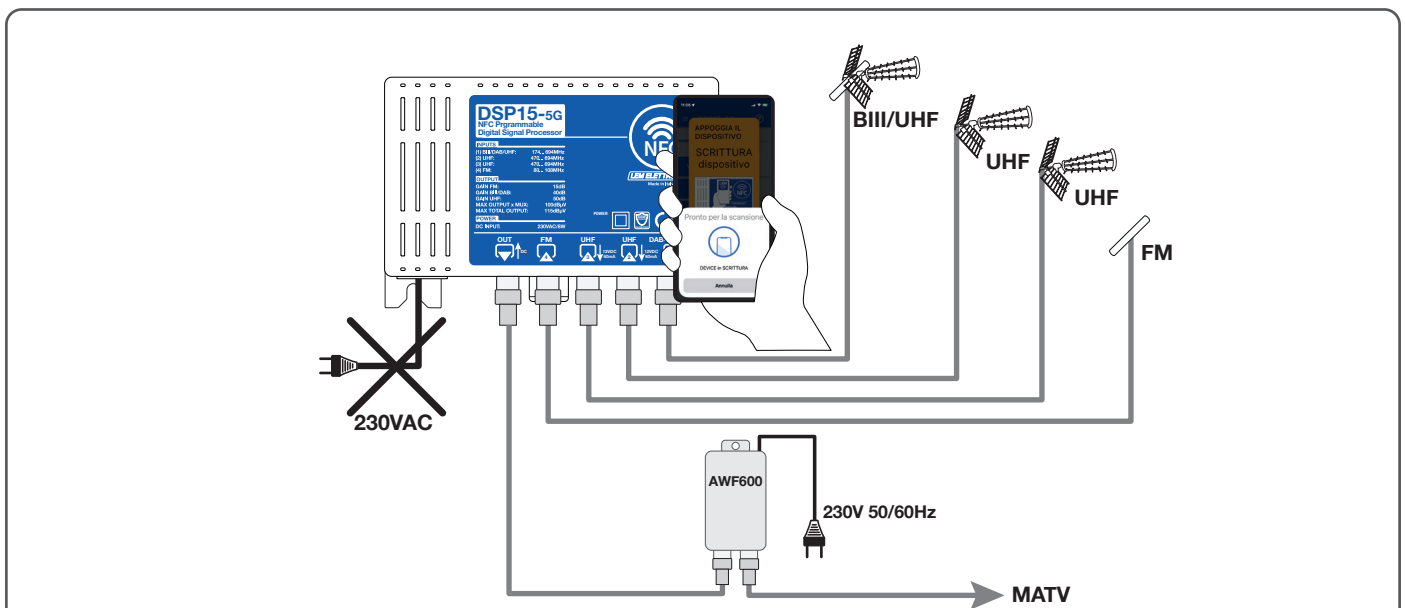
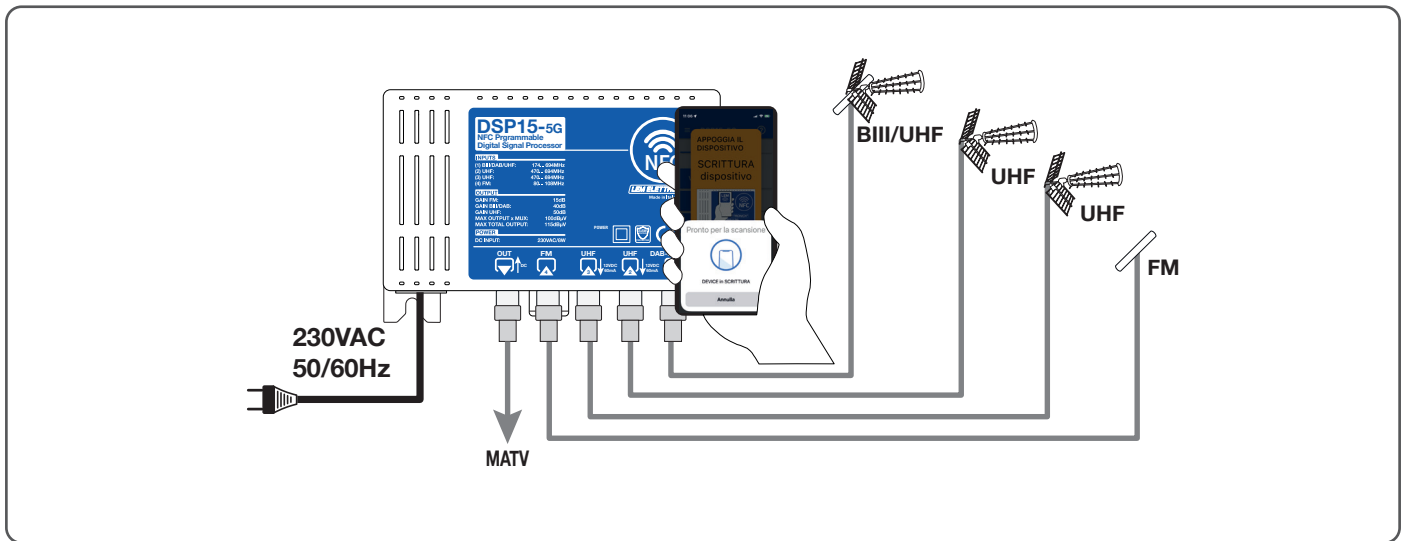

Remote power supply via coaxial cable

without an electrical outlet, the **DSA15-5G** amplifier can also be powered remotely from the output using a **12VDC** power supply of adequate power such as the **AWF600**..

Automatic equalization and slope adjustment

Once the configuration has been transmitted, each filter is automatically equalized to obtain a perfectly flat output spectrum. If the characteristics of the system require it, a positive SLOPE can be added to compensate the attenuation of the coaxial cables. The presence of automatic gain control C.A.G, which operates independently and in real time for each filter, ensures output signals with levels that are always constant over time.

