

SCF316/8

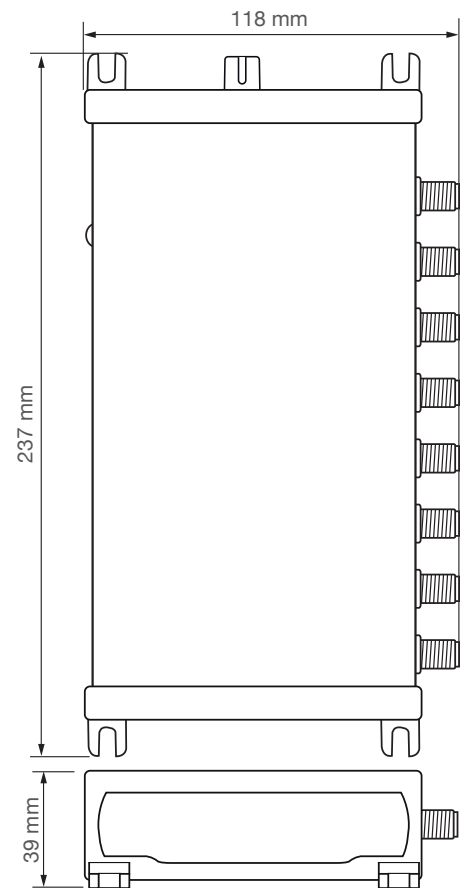





Optical Input Multiswitch User manual

- 8 Legacy/dCSS - DTT/DAB/FM outputs
- Led monitor optical link
- A.C.G. for each output
- Selectable Low/High satellite output level
- Level adjuster for TV terrestrial signal

Ready for **UHDTV** **MADE IN ITALY**



MODEL		SCF316/8
OPTICAL INPUT		1
RF OUTPUTS		8
OPTICAL		
OPERATION WAVELENGTH	nm	1310 - 1330 - 1550
INPUT POWER RANGE	dBm	-14... 0
INPUT CONNECTOR TYPE		SC/APC
RETURN LOSS	dB	≥40
SATELLITE		
OUTPUT BANDWIDTH	MHz	950... 2150
SCR/dCSS OUTPUT LEVEL	dBμV	85 Low / 94 High
LEGACY OUTPUT LEVEL	dBμV	75 Low / 80 High
SATELLITE OUTPUTS CONTROL STANDARDS		LEGACY/EN50494/EN50607/SKY UK (AUTO-SWITCH)
AVAILABLE USER BAND FREQUENCY PLANS		SKY ITALIA - SKY UK
TV TERRESTRIAL / FM / DAB		
OUTPUT BANDWIDTH	MHz	40... 790
MAXIMUM OUTPUT LEVEL	dBμV	85
OUTPUT LEVEL ADJUSTABLE RANGE	dB	0... -20
OTHERS		
ISOLATION BETWEEN SATELLITE/TERRESTRIAL	dB	≥ 40
ISOLATION V / H	dB	> 30
OUTPUT RETURN LOSS	dB	> 10
DC INPUT VOLTAGE RANGE	V	12... 20
MAXIMUM CONSUMPTION	W	16
OPERATING TEMPERATURE	°C	0... 50
DIMENSIONS	mm	237x118x38

DESCRIPTION OF SYMBOLS AND ELECTRICAL SAFETY	
	The equipment complies with the CE requirements
	The equipment is designed for indoor use only
	Equipment grounding terminal
	This symbol indicates that the equipment complies with the class II equipment safety requirements
	To avoid the risk of electric shock, do not open the equipment.
	The equipment is compliant with RoHS 2011/65EU
	Dispose according to local authorities recycling processes

Safety instructions

1. Read carefully these instructions
2. Keep these instructions
3. Heed all warnings
4. Follow all instructions
5. Do not expose this apparatus to extreme temperatures
6. Do not install this apparatus near water or expose to rain and moisture
7. Place the apparatus in a dry and well-aired location
8. Install the unit on a vertical wall, or in a waterproof cabinet with a minimum IP55 rating, and fix it safely using the provided fixing plugs
9. Do not install the unit lying flat or on its top
10. Connect the power adapter cord to a detachable power supply socket
11. Unplug the apparatus during lightning storms or when unused for long time
12. Only use accessories specified by the manufacturer
13. Do not remove the cover without disconnecting from the mains first
14. Ambient temperature should not be lower than 0°C and higher than 50°C
15. Please allow air circulation around the apparatus



Installation warnings

Place the apparatus and the power supplier in a dry and well-aired location

Install the unit on a vertical wall, or in a waterproof cabinet with a minimum IP55 rating, and fix it safely using the provided fixing plugs

Use only the power supplier YS25-1501250 provided with the amplifier.

The use of not-original power suppliers determines the not-compliance of the product and can cause malfunctions and void the warranty

Minimum recommended distance

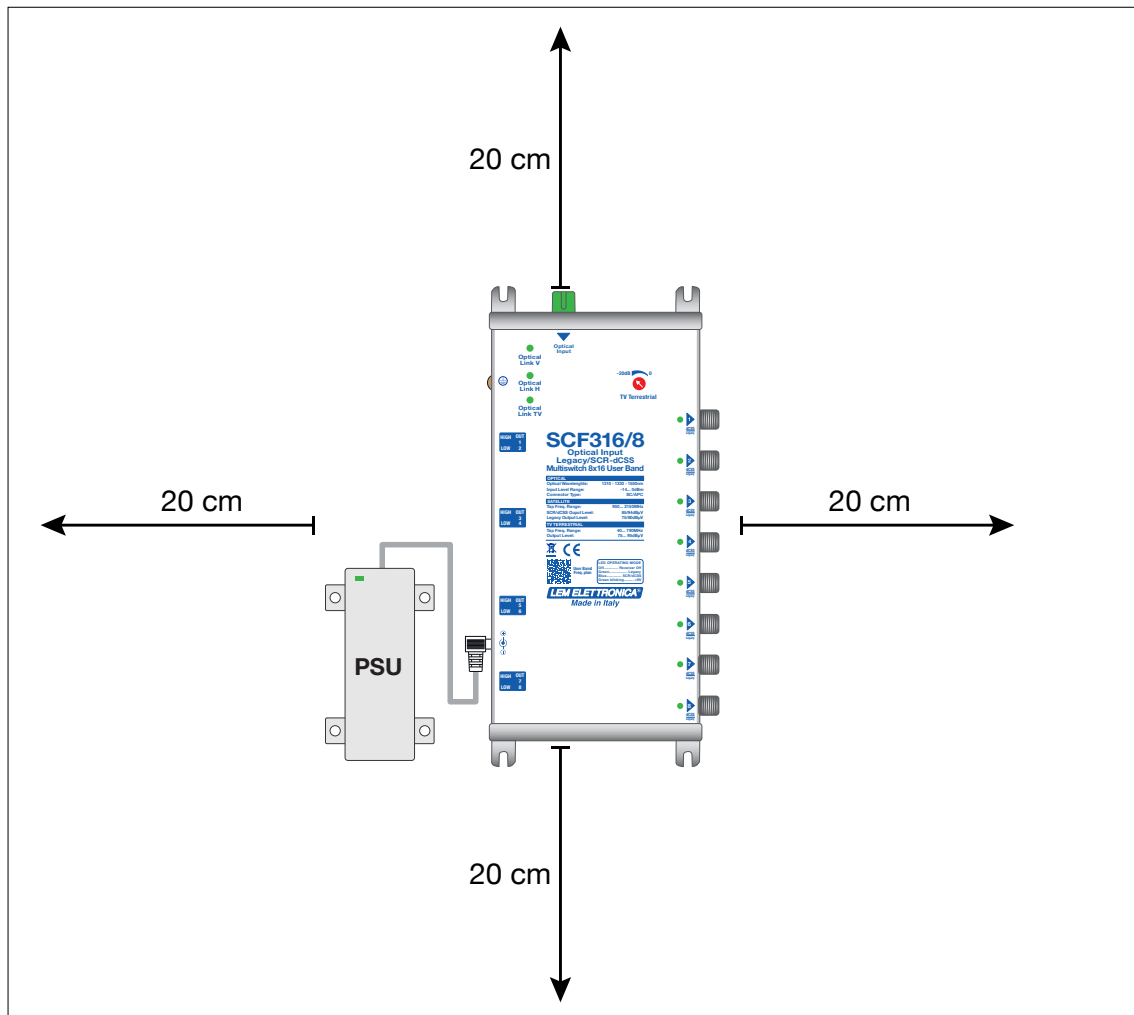

SCF316/8 DESCRIPTION

Content

01 Optical Multiswitch **SCF316/8**

01 Power supplier YS25-1501250 (Input: 100-240Vac 0,5A Max / Output: 15Vdc 1,25A Max)

08 6x30mm fixing plugs with 4,5x40mm screws

01 User manual

- ① Optical SC/APC input
- ② Terrestrial signals output level adjuster
- ③ SCR/dCSS - Legacy output Led status
- ④ Terrestrial/SCR/dCSS - Legacy Outputs
- ⑤ Satellite High/Low level outputs (5) e (6) selector
- ⑥ DC input 12... 20 Volt
- ⑦ Satellite High/Low level outputs (3) e (4) selector
- ⑧ Satellite High/Low level outputs (1) e (2) selector
- ⑨ Equipotential bonding
- ⑩ Optical link Status Led

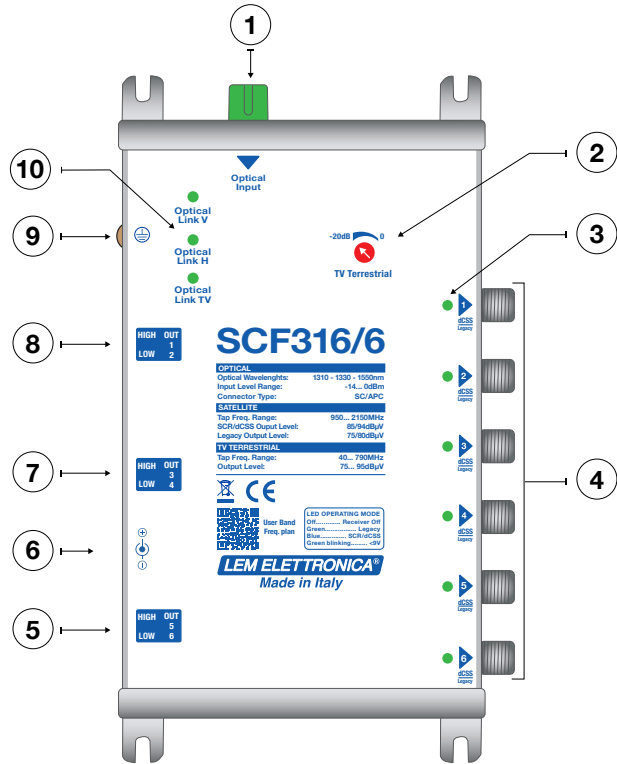

The optical signal level at the input of the multiswitch **SCF316/8** must lie between 0dBm e -14dBm.



Optical signals higher than 0dBm can irreversibly damage the **SCF316/8** multiswitch. In PON with less than 4 optical points add a proper optical attenuator.

MONITOR LED DESCRIPTION

DC Input

Off= No power

Green= Power

Optical Link

Off= No optical link

Green= Optical link

Outputs

Multiswitch mode selected

Off= any voltage from set-top-box

Green blinking= Voltage from set-top-box < di 9 Volt

Green= Legacy mode (auto-switch)

Blue= SCR/dCSS mode (auto-switch)

Quattro mode selected

Green for all outputs

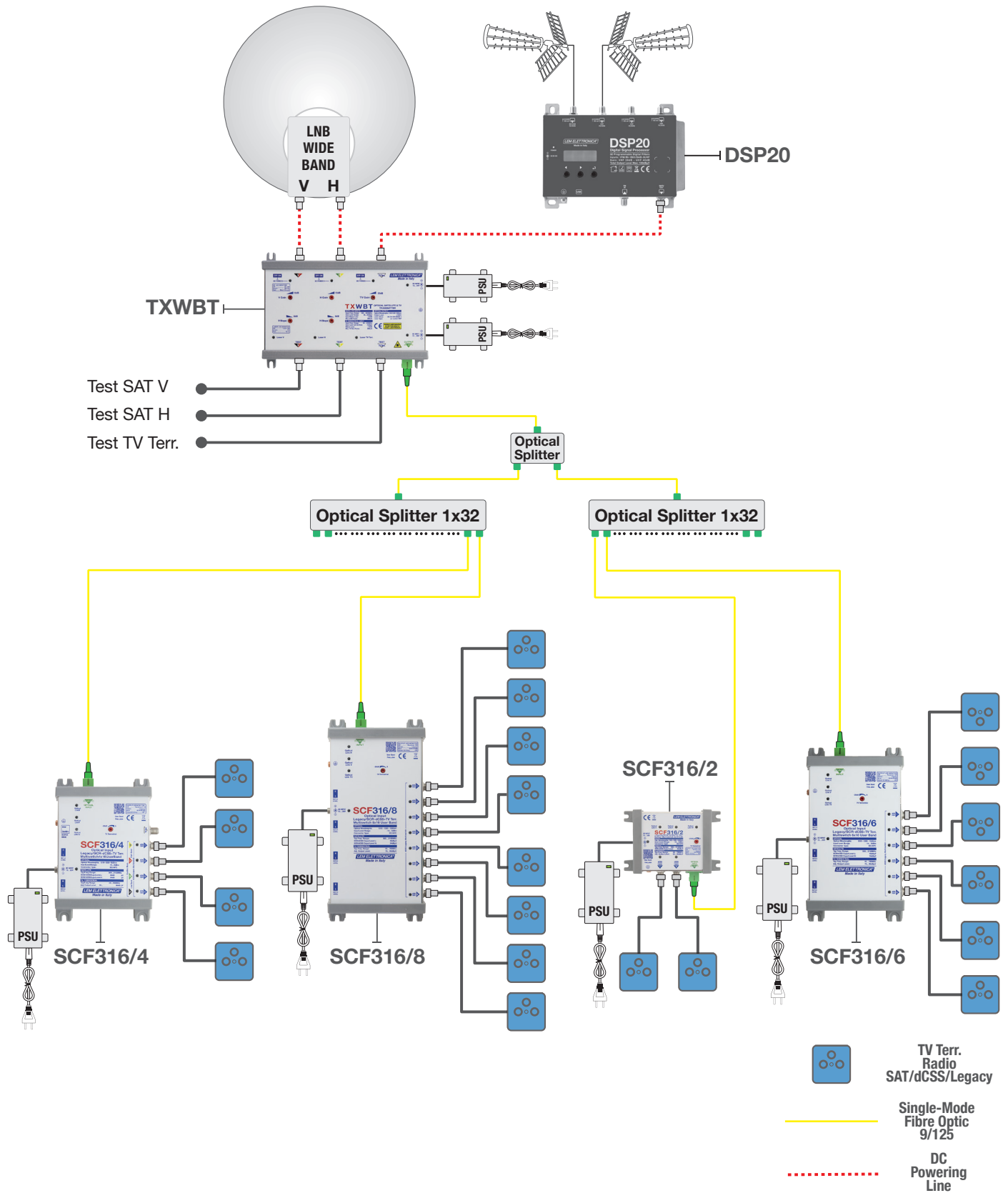

The **TXWBT** headend converts and transmits over a single-mode optical fibre the terrestrial signals (DTT, FM, DAB) processed by the programmable terrestrial headend **DSP20** and all the transponders of a satellite received from a Wide Band LNB. The optical signals are received by the optical multiswitch of the **SCF316** series and converted into RF ready for a single or multi-dwelling coaxial distribution. Each **SCF316** series output provides terrestrial and satellite signals supporting the legacy or SCR/dCSS standards (AUTO-SWITCH).

USER BAND FREQUENCY PLAN

EN 50494 (SCR Standard)	EN 50607 (SCD2 / dCSS)
UB1: 1210 MHz	UB1: 1210 MHz
UB2: 1420 MHz	UB2: 1420 MHz
UB3: 1680 MHz	UB3: 1680 MHz
UB4: 2040 MHz	UB4: 2040 MHz
UB5: 985 MHz	UB5: 985 MHz
UB6: 1050 MHz	UB6: 1050 MHz
UB7: 1115 MHz	UB7: 1115 MHz
UB8: 1275 MHz	UB8: 1275 MHz
	UB9: 1340 MHz
	UB10: 1485 MHz
	UB11: 1550 MHz
	UB12: 1615 MHz
	UB13: 1745 MHz
	UB14: 1810 MHz
	UB15: 1875 MHz
	UB16: 1940 MHz

Label with serial and tracking data

AA1000015019-X1020L

Model Serial # Manuf. Week Manuf. Year HW Rel. FW Rel.

LEM ELETTRONICA srl • Via Grezze, 38 • 25015 Desenzano d/G • Italy
Tel. +39 0309120006 • Fax. +39 0309123035 • info@lemelettronica.it
www.lemelettronica.it