

SCF516/6

User manual

Optical Receiver 2 Satellites orbital position 6 Outputs

- Reception of 2 satellites and terrestrial feed
- 6 Legacy/dSCR - DTT/DAB/FM outputs
- Output booster for satellite signals
- Optical link monitor Led
- A.G.C. for each output

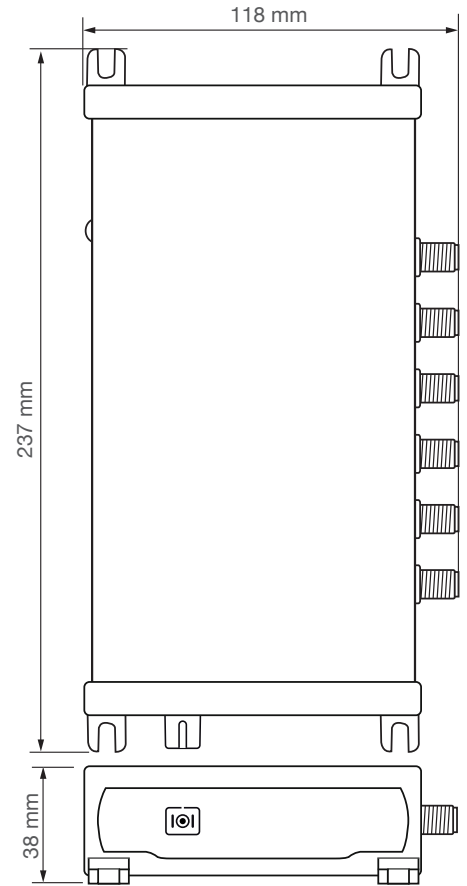





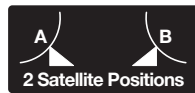

Ready for
UHDTV

**MADE IN
ITALY**



Rel. 1.0

MODEL		SCF516/6
OPTICAL INPUT		1
RF OUTPUTS		6
OPTICAL		
OPERATION WAVELENGTHS	nm	1.270 - 1310 - 1330 - 1.490 - 1550
INPUT POWER RANGE	dBm	-14... 0
INPUT CONNECTOR TYPE		SC/APC
RETURN LOSS	dB	≥40
SATELLITE		
OUTPUT BANDWIDTH	MHz	950... 2150
SCR/dCSS OUTPUT LEVEL	dBμV	85 Booster OFF / 94 Booster ON
LEGACY OUTPUT LEVEL	dBμV	75 Booster OFF / 80 Booster ON
SATELLITE CONTROL STANDARDS		Universal LNB Voltage & Tone / DiSEqC 1.0 / DiSEqC 2.0
SCR/dCSS/DSCR PROTOCOLS		EN50494 / EN50607 / SKY UK (AUTO-SWITCH)
AVAILABLE USER BAND FREQUENCY PLANS		SKY ITALIA - SKY UK
TV TERRESTRIAL / FM / DAB		
OUTPUT BANDWIDTH	MHz	40... 790
MAXIMUM OUTPUT LEVEL MIX OUT	dBμV	≥75
OUTPUT LEVEL ADJUSTMENT	dB	0... -20
OTHERS		
ISOLATION BETWEEN SATELLITE/TERRESTRIAL	dB	≥ 40
ISOLATION V / H	dB	> 30
OUTPUT RETURN LOSS	dB	> 10
DC INPUT VOLTAGE RANGE	V	12... 20
MAXIMUM CONSUMPTION	W	16
OPERATING TEMPERATURE	°C	0... 50
DIMENSIONS	mm	237 x 118 x 38

DESCRIPTION OF SYMBOLS AND ELECTRICAL SAFETY	
	The equipment complies with the CE requirements
	The equipment is designed for indoor use only
	Equipment grounding terminal
	This symbol indicates that the equipment complies with the class II equipment safety requirements
	To avoid the risk of electric shock, do not open the equipment.
	The equipment is compliant with RoHS 2011/65EU
	Dispose according to local authorities recycling processes

Safety instructions

1. Read carefully these instructions
2. Keep these instructions
3. Heed all warnings
4. Follow all instructions
5. Do not expose this apparatus to extreme temperatures
6. Do not install this apparatus near water or expose to rain and moisture
7. Place the apparatus in a dry and well-aired location
8. Install the unit on a vertical wall, or in a waterproof cabinet with a minimum IP55 rating, and fix it safely using the provided fixing plugs
9. Do not install the unit lying flat or on its top
10. Connect the power adapter cord to a detachable power supply socket
11. Unplug the apparatus during lightning storms or when unused for long time
12. Only use accessories specified by the manufacturer
13. Do not remove the cover without disconnecting from the mains first
14. Ambient temperature should not be lower than 0°C and higher than 50°C
15. Please allow air circulation around the apparatus



Installation warnings

Place the apparatus and the power supplier in a dry and well-aired location

Install the unit on a vertical wall, or in a waterproof cabinet with a minimum IP55 rating, and fix it safely using the provided fixing plugs

Use only the power supplier YS25-1501250 provided with the amplifier.

The use of not-original power suppliers determines the not-compliance of the product and can cause malfunctions and void the warranty

Minimum recommended distance

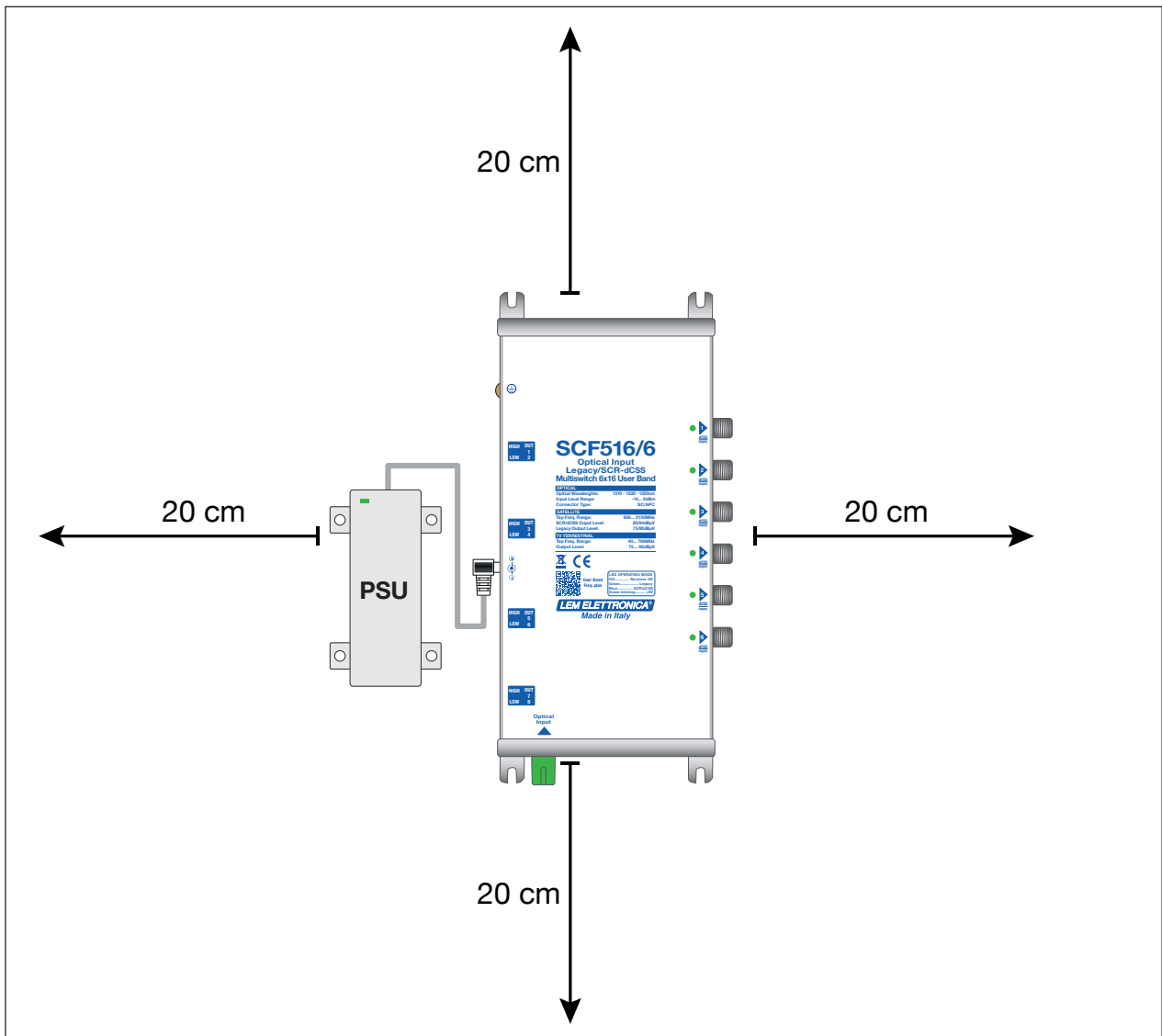

SCF516/6 DESCRIPTION

Box Content

01 Optical Multiswitch SCF516/6

01 Power supplier YS25-1501250 (Input: 100-240Vac 0,5A Max / Output: 15Vdc 1,25A Max)

08 6x30mm fixing plugs with 4,5x40mm screws

01 User manual

- ① Terrestrial signals output level adjuster
- ② Legacy/dSCR-Terrestrial Outputs
- ③ SCR/dCSS - Legacy output Led status
- ④ Optical SC/APC input
- ⑤ Satellite booster ON/OFF outputs (5) and (6)
- ⑥ Satellite booster ON/OFF outputs (3) and (4)
- ⑦ DC input 12... 20 Volt + Power status Led
- ⑧ Satellite booster ON/OFF outputs (1) and (2)
- ⑨ Ground clamp
- ⑩ Optical link Status Led

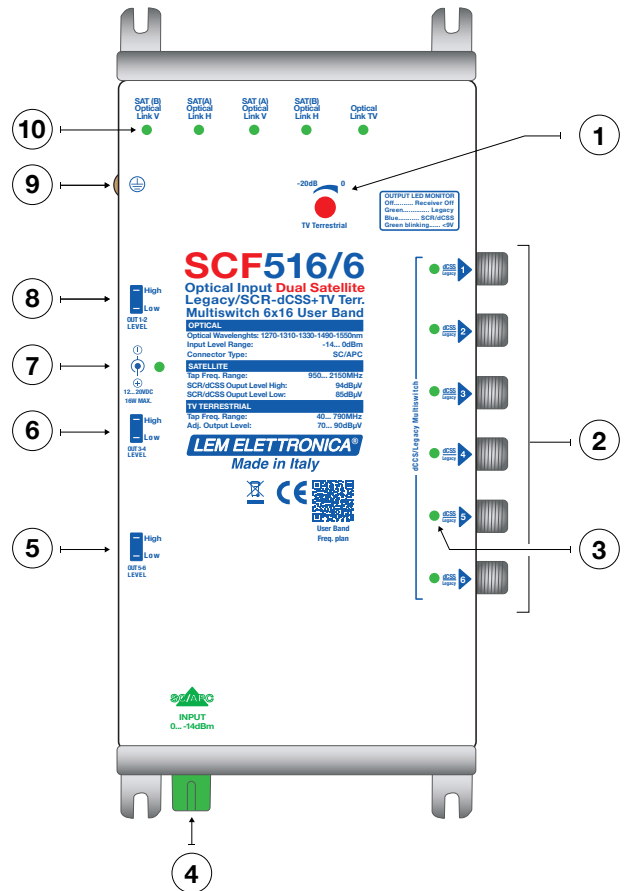

The optical signal level at the input of the multiswitch **SCF516/6** must lie between 0dBm and -14dBm.



Optical signals higher than 0dBm can damage the **SCF516/6** multiswitch.

In PON with less than 4 optical points add a proper optical attenuator.

MONITOR LED DESCRIPTION

DC Input

Off= No power

Green= Power

Optical Link

Off= No optical link

Green= Optical link

Outputs

Multiswitch mode selected

Off= any voltage from set-top-box

Green blinking= Voltage from set-top-box < di 9 Volt

Green= Legacy mode (auto-switch)

Blue= SCR/dCSS mode (auto-switch)

Quattro mode selected

Green for all outputs

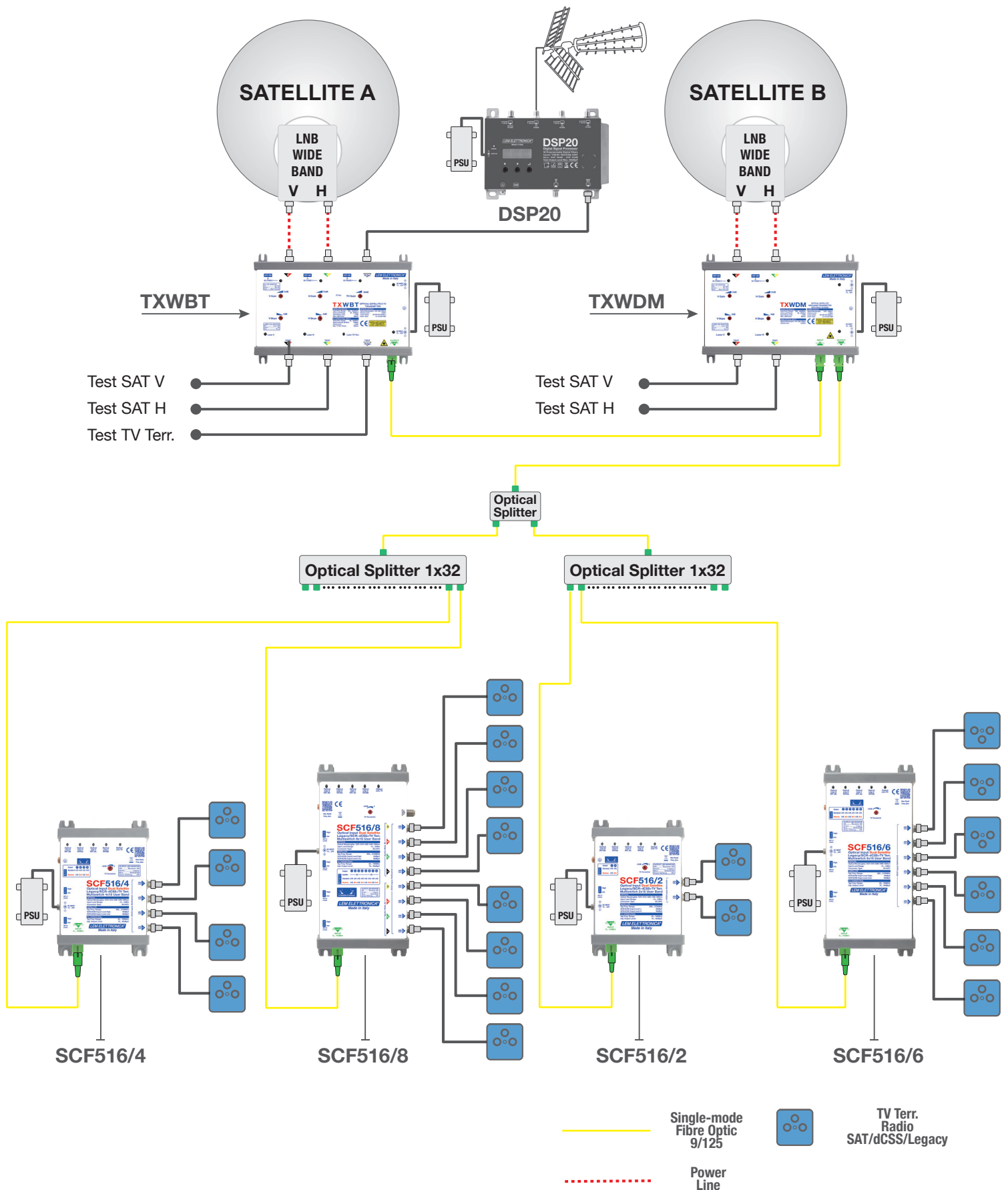

Distribution of two satellite and terrestrial feed (DTT, FM, DAB) over a single-mode optical fibre

The headends **TXWBT** and **TXWDM** convert and transmit over a single-mode fibre optical cable the terrestrial feeds and all the transponders of two satellite received from two Wide Band LNB. The optical multiswitches of the **SCF516** series receive and converted into RF to be ready for a single or multi-dwelling coaxial distribution. Each **SCF516** series multiswitch output provides terrestrial and satellite signals and fully supports Diseq controls in legacy and SCR/dCSS standards.

Label with serial and tracking data

AA1000015019-X1020L

AA	100001	50	19	-X	10	20	L
Model	Serial #	Manuf. Week	Manuf. Year		HW Rel.	FW Rel.	